

# Ropox Mobilio Shower bed

User manual



This manual should always be in close proximity of the product.

## Table of content



<b>1. Symbols used in this manual</b> .....	<b>4</b>
<b>2. General safety</b> .....	<b>4</b>
2.1 Product label .....	5
<b>3. General requirements</b> .....	<b>6</b>
3.1 Product information .....	6
3.2 Intended use.....	7
3.3 Intended operator .....	7
3.4 Dimensions.....	8
<b>4. Instructions for use</b> .....	<b>9</b>
4.1 Product assembly .....	9
4.1.1 Assembly of legs .....	9
4.1.2 Connection of wires in the controlbox .....	10
4.2 Operating the product .....	11
4.2.1 Actuation of the product.....	11
4.2.2 Activation and release of brake systems.....	12
4.2.3 Operation of the bed guards.....	12
4.3 Installation of battery.....	13
4.3.1 Mounting the battery .....	13
4.3.2 Connecting the battery .....	13
4.3.3 Charging the battery .....	14
4.3.4 Battery feedback indicators .....	14
4.4 Electric block diagram.....	14
<b>5. Cleaning</b> .....	<b>15</b>
<b>6. Maintenance</b> .....	<b>15</b>
6.1 Periodic maintenance of bed guards .....	15
6.2 Periodic charging of battery .....	15
6.3 Replacement of battery.....	16
6.4 Fault finding .....	16
6.5 Calibration of lifting columns.....	16
<b>7. Environmental protection</b> .....	<b>16</b>
<b>8. Accessories</b> .....	<b>17</b>
8.1 Battery.....	17
8.2 Cushion for bed guards .....	17
8.5 Central brake system.....	18
<b>9. Electro magnetic compatibility</b> .....	<b>18</b>
9.1 Suitable Environments .....	18
9.2 Basic safety and Essential performance .....	18
9.3 Adjacent and stacked use.....	18
9.4 Cables.....	19
9.5 RF portable equipment .....	19
9.6 Compliance for emission and immunity standard.....	19
9.6.1 Emission class and group.....	19

9.6.2 Immunity test levels ..... 20

# 1. Symbols used in this manual

<p><b>Warning Symbol</b></p> <p>Indication of potentially hazardous situation. If not avoided it can result in serious injury or death.</p>	
<p><b>Caution Symbol</b></p> <p>Indication of potentially hazardous situation which may result in minor or moderate injury. It may also be used to alert against unsafe practices.</p>	
<p><b>Notification Symbol</b></p> <p>This symbol is used to notify correct use and handling of the product.</p>	

## 2. General safety

	<p>This manual must be read and understood before use. Always keep this manual in close proximity of the product.</p> <p>The use, installation and service of this product must be in compliance with this manual to avoid accidents and serious personal injury.</p> <p>Never use or handle this product in other ways specified in this manual as it can result in personal safety hazards and/or cause damage to the product.</p> <p>Persons installing and/or are using this product either as operator or patient should have the necessary safety information and access to this manual.</p>
	<p>Always comply with instructions in this manual to avoid damaging or destroying the product. Not doing so can cause the safety of this product to be compromised.</p> <p>Do not perform repairs, disassembly or assembly operations, add-ons, re-adjustments or modification of the product beyond what is described in this manual. These must be carried out by Ropox or Ropox authorized personnel. Do not perform service while in use with a patient.</p> <p>Do not allow children to operate this product unless they are under supervision from an adult that has read and understood this manual. The product is not intended to play with.</p> <p>Do not use the product if it has defects or have become damaged before being repaired or replaced.</p>
	<p>The information in this manual is based on correct installation in accordance with installation instructions for this product.</p> <p>Ropox cannot be held liable if the product is used in any way that differs from stated in this manual and/or installation instruction.</p> <p>Ropox reserve the right to amend this manual and reference documents without prior notice.</p>

## 2.1 Product label

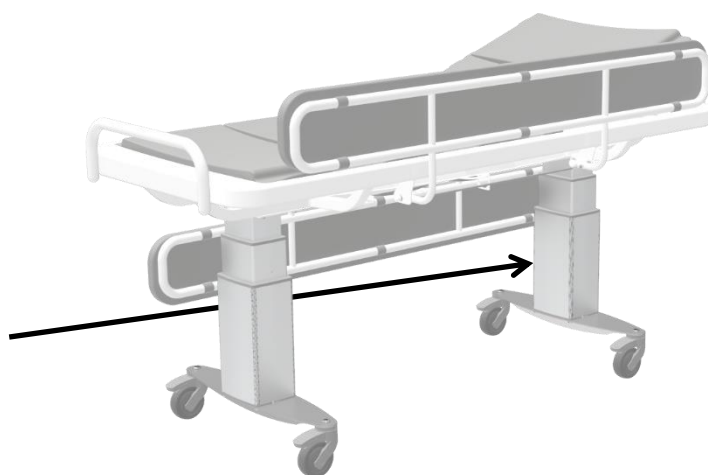
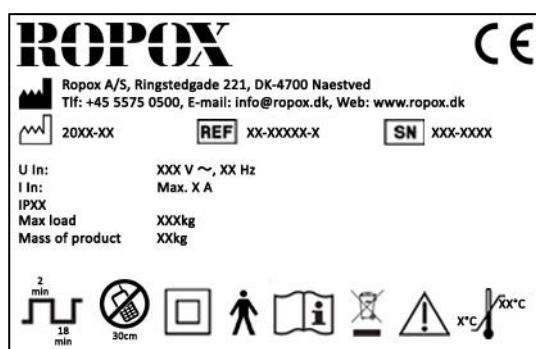

	This product is CE-marked in accordance with the Regulation (EU) 2017/745 Council Directive 2006/42/EC Council Directive 2011/65/EU
	Manufacturer name and address
	Date of production
<b>REF</b>	Stock number
<b>SN</b>	Serial number
	Consult manual before use
	Operating interval of electrically operated equipment. The use of electrical height adjustable equipment can run at maximum 2 minutes, followed by an 18-minute break.
	Type B applied part. The product complies with IEC 60601-1 requirements to provide protection against electric shock.
	Consult manual for important safety related information, warnings and safety precautions.
	Class II, double isolated electrical components.
	Do not dispose as unsorted municipal waste. Product must be returned to a designated recycling station.
	Mobile phones or other portable RF emitting equipment should be no closer to the product than 30cm.
	Operating and storing temperatures may not exceed 5-40°C°

## 3. General requirements

### 3.1 Product information

Manufacturer:	Ropox A/S Ringstedgade 221, DK-4700 Naestved +45 55 75 05 00 Email: Info@ropox.com		
Product models	Part number	Model	Configuration
	40-31406-1 40-31410-1 40-31411-1	Mobilio Shower Bed 148x76cm Mobilio Shower Bed 178x76cm Mobilio Shower Bed 210x76cm	Standard lockable wheels
MDR Class (EU) 2017/745	<b>Class I</b>		
Applied part classification 60601-1	<b>Type B</b> applied part		
MEE Class 60601-1	<b>Class II</b>		
Height adjustment	59-99cm		
Speed of actuation	≈ 18mm/s		
Maximum user weight according to EN12182:2012	200kg		
Power supply	100-240V ~50/60Hz		
I in	Max 2.0A		
Intermittence	2min use / 18min pause		
IP rating	IPX6		
Ambient temperature	5-40C° Operation and storage		
Materials in contact with patient	Tub	ABS/PMMA	
	Cushion for bed guard	Dahlia fabric Backing: 100% polyester Coating: 100% Polyurethane ISO 10993-10 Non Allergic	
	Bed guard	St37 tube steel, powder coated	
	Slats	PUR FLEX 200	
Intended environments	This product is to be used only in: Professional Healthcare Environment Homecare Environment  <i>The device is not intended for use in special environments as defined by IEC 60601-1-2</i>		
Accessories	BA19 Lead acid battery 40-30762	<b>Specification</b>	
		<ul style="list-style-type: none"> <li>• Lead acid technology: Lead acid</li> <li>• Output voltage: 24 V DC</li> <li>• Max. discharge current: 6 A</li> <li>• Charging current: 300 mA, controlled by BA19 internal charger</li> <li>• Capacity: 1.2 Ah / 28.8 Wh</li> <li>• Weight: 1.6 kg</li> </ul>	
		<b>Usage</b>	

	<p>Cushion for bed guard 40-25782-1 40-25783-1</p> <p>Central brake system 40-30753-2 40-30760-2 40-30763-2</p>	<ul style="list-style-type: none"> <li>• Compatibility: Battery backup for CA30/CA40 and CO61</li> <li>• Duty cycle: 10%, 2 minutes continuous use followed by 18 minutes not in use</li> <li>• Charging: Via integrated charger</li> <li>• Charging time: Approx. 6 hours</li> <li>• Recharging during storage: Battery recharging no later than 6 months after production date stated on the label</li> <li>• Operating temperature: +5°C to +40°C</li> <li>• Storage temperature: -5°C to +40°C The batteries must be stored in an applicable storage room to avoid direct sunlight</li> <li>• Relative humidity: 20% to 80%, but non-condensing acc. to temp.</li> <li>• Atmospheric pressure: 700 to 1060 hPa</li> <li>• Service: Battery cells cannot be replaced as the battery cover cannot be closed properly afterwards</li> </ul> <p>For L= 148cm For L= 178cm, 210cm</p> <p>For L= 148cm For L= 178cm For L= 210cm</p>
--	---	--

### **3.2 Intended use**

The mobile height adjustable shower bed can be used to nurse children and adults up to 200 kg. The shower bed is intended for use in private homes, day-care centers, day centers for persons with physical or mental disabilities, or similar institutions, to provide the right and optimal working conditions for the staff. The mobile shower bed can be used in both dry and wet rooms. The shower bed is freestanding, mobile and with brake wheels to ensure optimum working conditions. The height of the work surface can be adjusted step less from 59-92'9 cm using a spiral cord handset.

### **3.3 Intended operator**

Reading and understanding this manual will be sufficient training for an intended operator. Children nor patient are not considered intended operator.

### 3.4 Dimensions

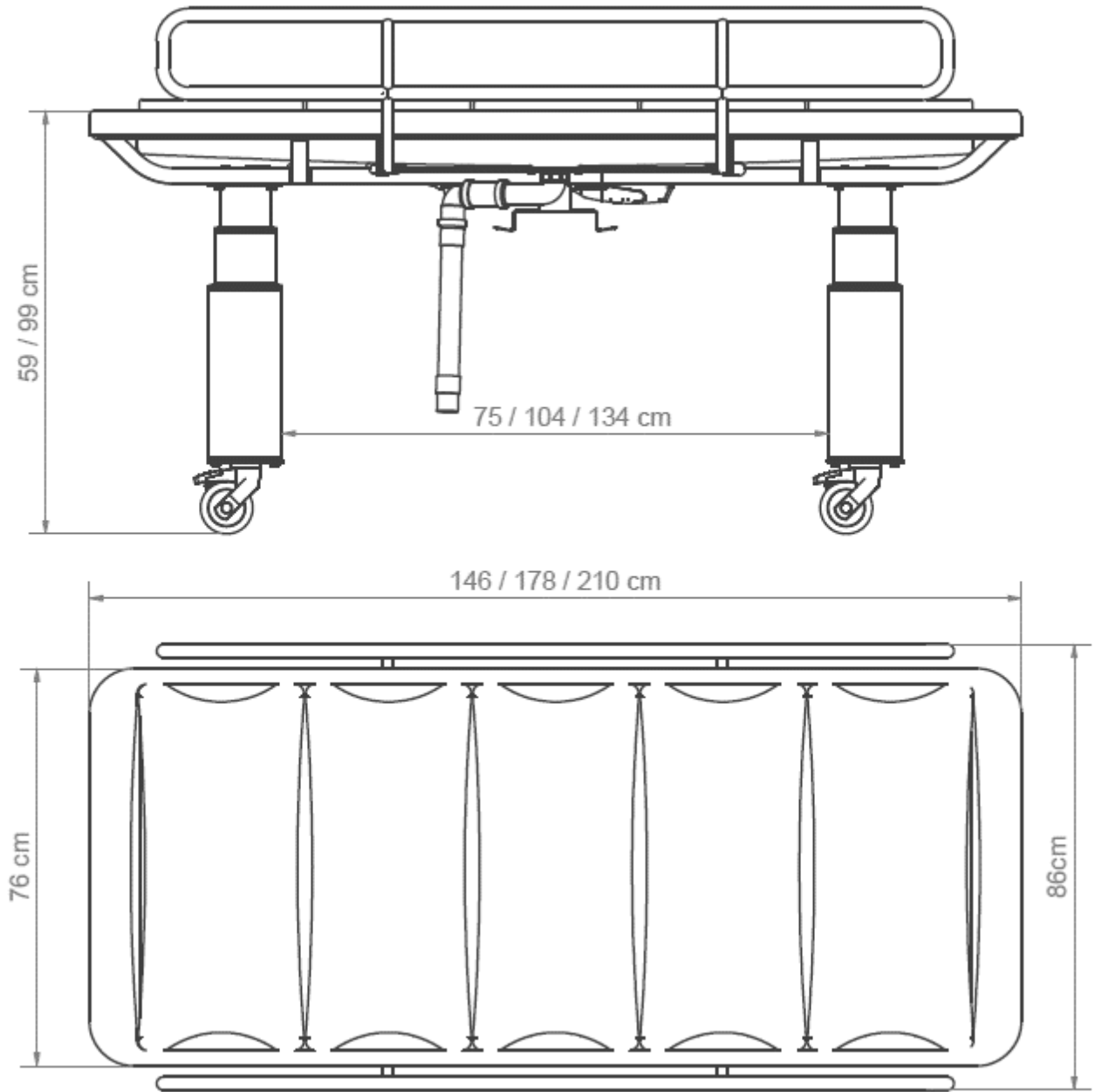



## 4. Instructions for use

### 4.1 Product assembly

#### 4.1.1 Assembly of legs

Mount the legs with 8x enclosed M8 bolts. It is recommended to cross tighten the 4 bolts, on each leg assembly.



#### Notification!

Remember to use locking shims! All bolts are tightened with a torque of **12Nm / 8.9ft/lbs**

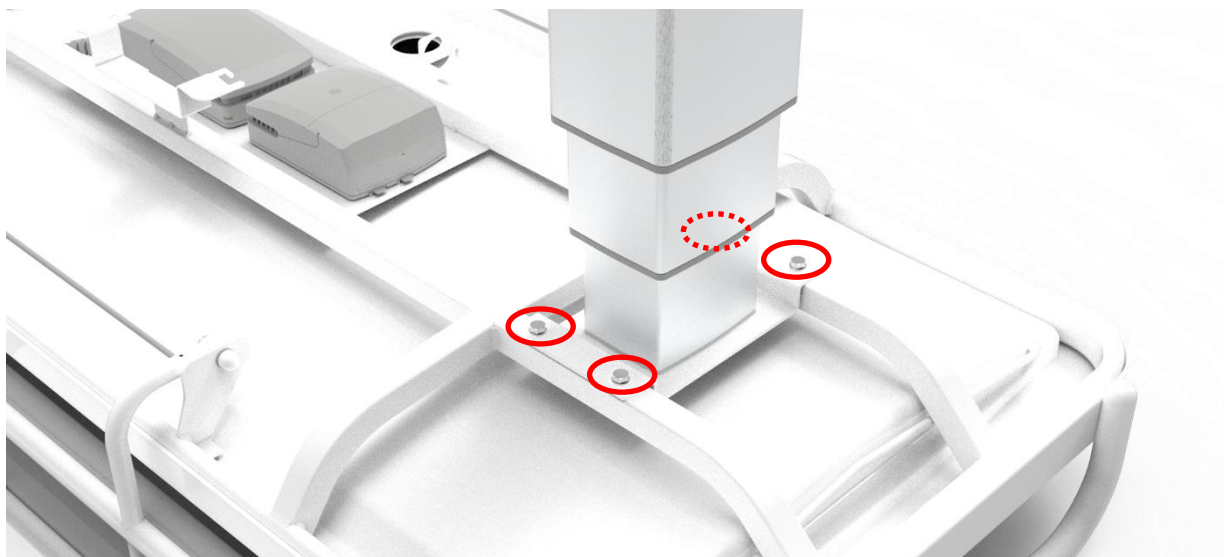

#### 4.1.2 Connection of wires in the controlbox

Wires are connected according to picture and designation shown below.

	<p><b>Notification!</b></p> <p>All wires are sealed with O-rings, make sure these are fully engaged by pushing the connectors firmly to the bottom of the socket.</p>
---	---

A	Motor cable 1
B	Motor cable 2
C	Handset
D	Battery (accessorie)

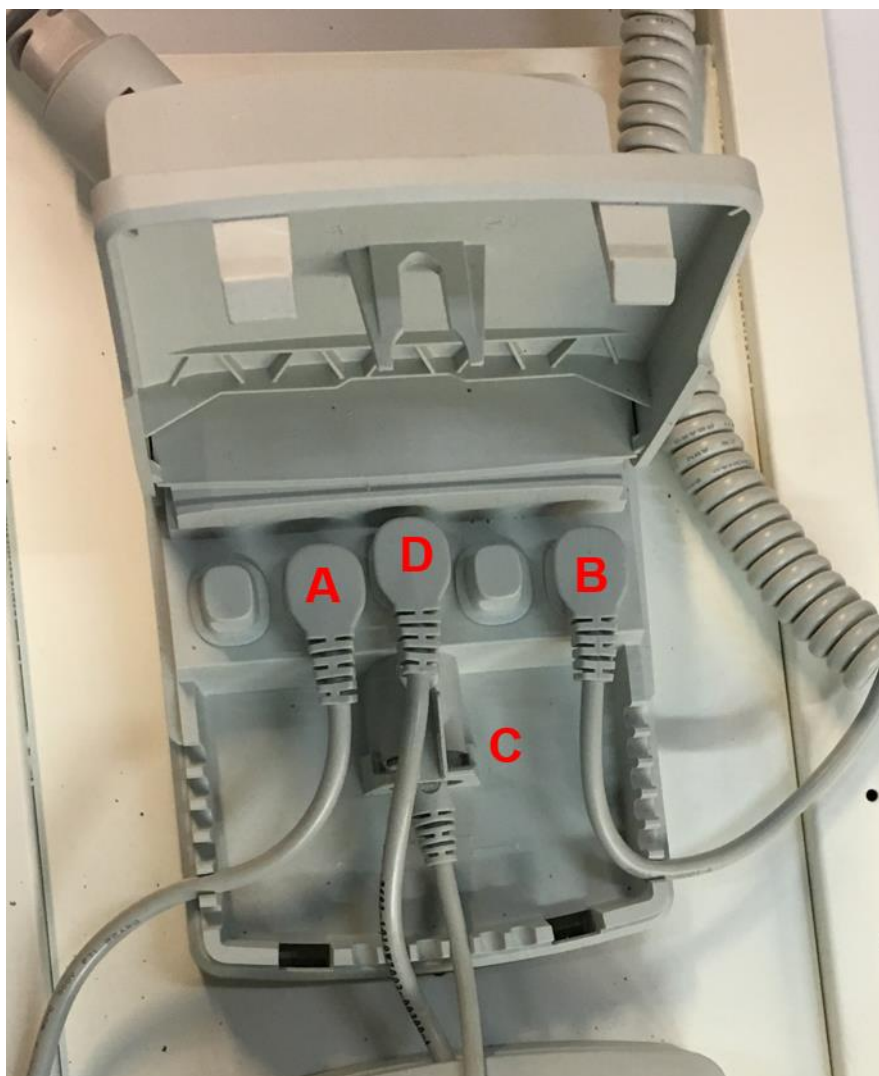

## 4.2 Operating the product

	<p><b>Warning!</b></p> <p>Before use always make sure that mains cable and hand control cable will be able to travel freely without the risk of squeezing or disconnecting the product as result of the movement.</p>
---	---

	<p><b>Caution!</b></p> <p>When connected to the mains the product must be placed in a manner according to power outlets so that the operator will be able to disconnect the product during use in case of an emergency.</p>
---	---

### 4.2.1 Actuation of the product

The product is operated with the spiral cord hand control. Arrow up will move the product upwards and arrow down will move the product downwards.

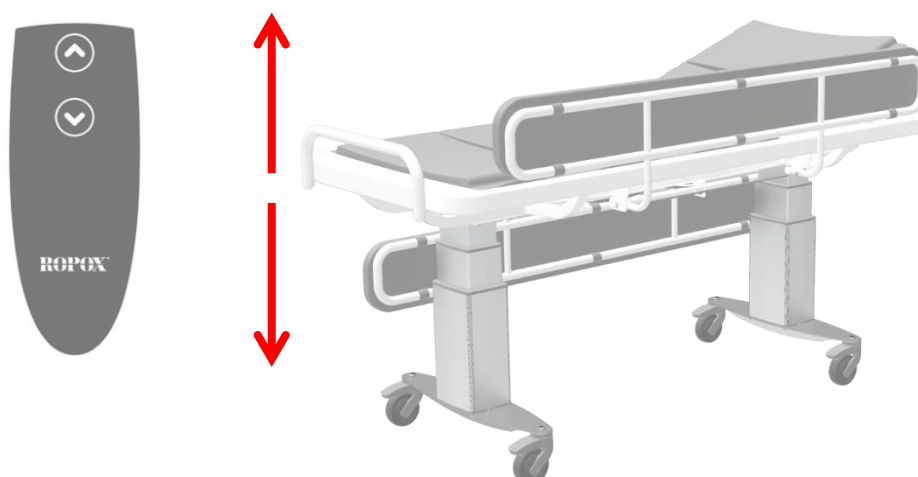

	<p><b>Warning!</b></p> <p>The product should always be able to travel the full range of actuation without colliding with objects. Failing to do so will compromise the product stability. Special care should be taken in ensuring that no children or adults are sited under the product as severer injury from entrapment may occur.</p>
---	--

## 4.2.2 Activation and release of brake systems

To activate the brake wheels use appropriated foot pad.

	<p><b>Caution!</b></p> <p>The central brake system or standard locking brakes must always be locked and secure before a patient is placed on the product.</p> <p>The product is not intended as a mean for patient transportation and the use of it must only be stationary.</p>
---	--

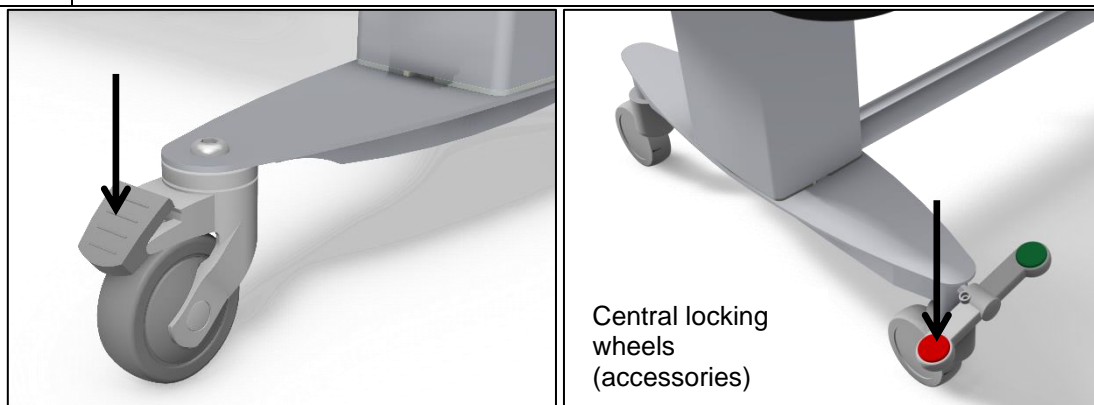

## 4.2.3 Operation of the bed guards

To operate the bed guards pull the rubber tubing placed under the table top to release the locking mechanism. The bed guard can then be pivoted to the desired mode.

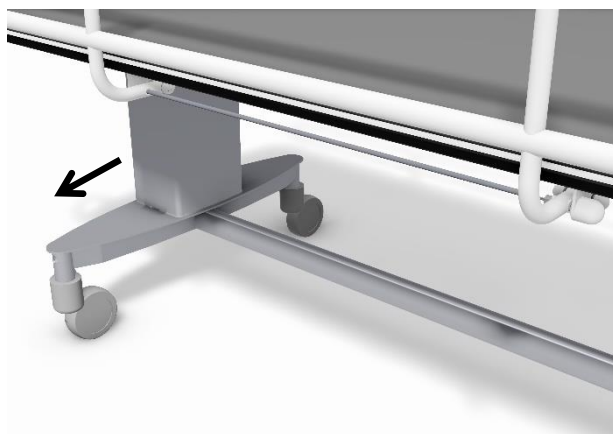

	<p><b>Warning!</b></p> <p>Make sure that the bed guard is locked securely in place when in use. Locking is checked by shaking the bed guard back and forth ensuring that the locking pin is fully engaged.</p>
---	--

### 4.3 Installation of battery

Mobilio is not supplied with a backup battery. This can be ordered as an accessory. To order a battery use the following part number: **40-30762**



	<p><b>Notefication!</b></p> <p>The installation of the battery must be in compliance with the following installation guide</p>
--	--

#### 4.3.1 Mounting the battery

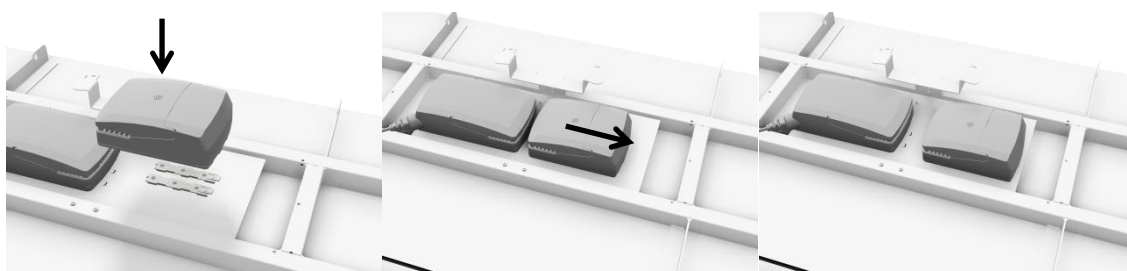

#### 4.3.2 Connecting the battery

- Stop actuation of lifting coloumns
- Switch of the controlbox by disconnecting the mains plug.
- Connect the battery to the port in the controlbox.

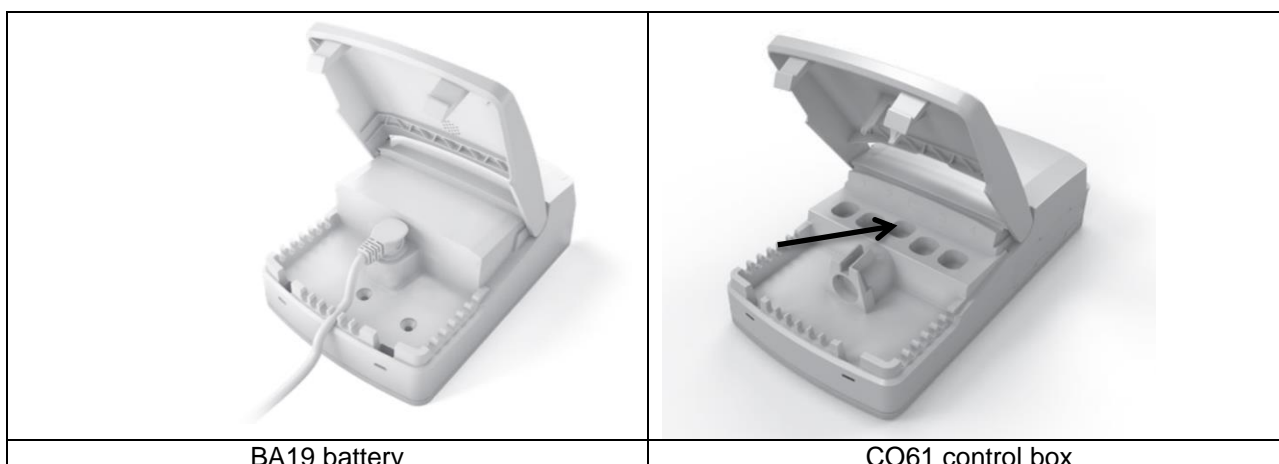

### 4.3.3 Charging the battery

The battery will automatically charge through an integrated charger when the product is connected to the mains. A full charging takes approx 6 hours and is indicated through the LED on the battery

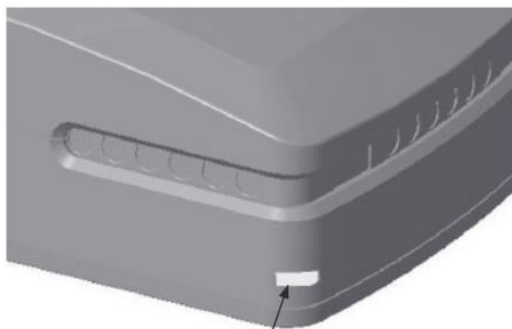

LED	Indication of operation
Solid orange	Charging (battery not ready)
No LED light	Fully charged (battery ready)

	<p><b>Notification!</b></p> <p>Before using the battery the first time make sure to charge it for 24hours. This will prolong the life of the battery.</p>
---	---

### 4.3.4 Battery feedback indicators

The battery has a built in buzzer that automatically gives feedback to the user when the capacity is low. This will sound when the product is operated with the hand control for adjusting the height.

	<p><b>Caution!</b></p> <p>Check battery capacity before use if the battery is the only power source. Make sure that the product is within distance of a power outlet to ensure continuous function of the product when used with a patient in case the battery become exhausted.</p>
---	--

## 4.4 Electric block diagram

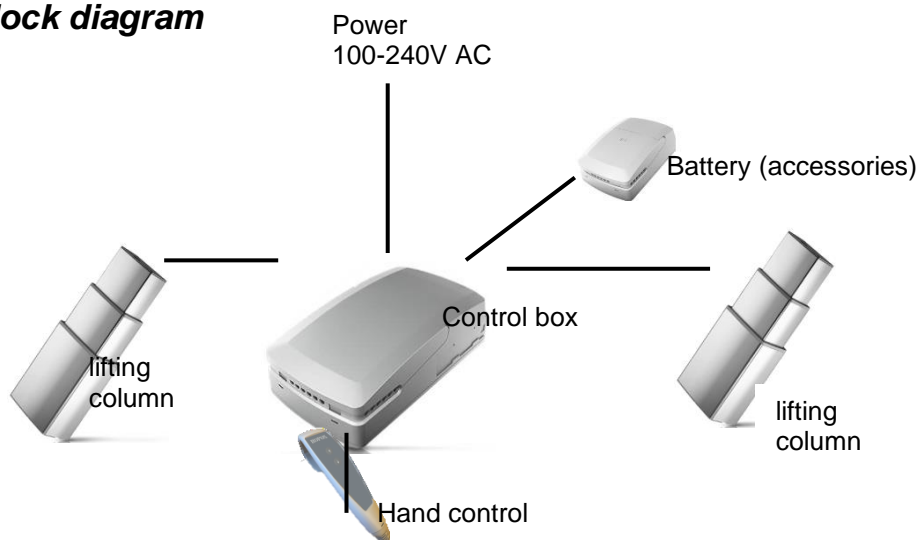

## 5. Cleaning

Cleaning can be done with lukewarm water and a suitable all purpose cleaning agent. Use a cloth or soft sponge to wash the product. Dry the product with a wrung cloth.

### Cleaning of slats

Lime deposits on slats are removed with a household bathroom cleaning agents

### Chemical resistance

Detergents containing the following chemicals must not be used for cleaning:

Acetone
Ammonium carbonate
Ethyl acetate
Formic acid
Hydrochloric acid
Isopropanol
Methyl acetate
Nitric acid
Phosphoric acid



#### Notification!

Do not use cleaning agents containing abrasive e.g. scouring powder, steel wool, scouring sponge.

This product is not designed to be sterilized, autoclaving and sterilization beyond normal cleaning is may possibly change the product safety and function.

## 6. Maintenance



#### Notification!

Failing to comply with periodic maintenance may result of degrading of product function and safety.

### 6.1 Periodic maintenance of bed guards

If the product is used humid or dry atmosphere the locking pin may be prone to seizing from lubricants drying. Besides checking the function of the locking mechanism before every use, a periodic lubrication of the locking pin every 6 month is recommended.

### 6.2 Periodic charging of battery

The battery must be periodically charged minimum every 6 months to sustain capacity. If the product is left unused or the battery is disconnected this may result degrading of the battery capacity. Charging the battery minimum every 6 months will mitigate this.

### 6.3 Replacement of battery

	<p><b>Notification!</b></p> <p>The battery are to be replaced after 4 years at the latest.</p>
---	--

### 6.4 Fault finding

Problem	Tjek følgende:
Mobilio does not move up or down when the hand-control switch is pressed	<ol style="list-style-type: none"> <li>1. The product is connected to 230V and the control box LED indicator lights green</li> <li>2. Motor cables are connected to control box</li> <li>3. The control switch has been connected with the control unit</li> <li>4. If the product is used with battery, check whether it is charged.</li> <li>5. The motors are overloaded (note: 2 min. ON, 18 min OFF).</li> </ol>
Control switch defective	<ol style="list-style-type: none"> <li>1. Mobilio works with another control switch</li> </ol>
Mobilio is not horizontal / level	<p><b>"Reset"</b></p> <p>Press and hold UP (▲) and DOWN (▼) buttons. Keep the buttons depressed until the control unit has beeped approx.. ten times. After that, the bathtub may be adjusted to the bottom position for resetting.</p> <ol style="list-style-type: none"> <li>1.</li> </ol>

### 6.5 Calibration of lifting columns

Lifting columns are aligned and calibrated from the factory. In case they need calibration to run simultaneously use the **"Reset"** procedure.

## 7. Environmental protection

The product is not intended to be disposed as municipal waste. Proper disassembly, sorting and disposal of components must be done by waste disposal professionals.



Part	Disposal recommendation
Tub	Hard plastic
Slats	Soft plastic
Bed guards	Steel waste
Frame and wheel assembly	Steel waste
Controlbox	Electronics
Lifting columns	Aluminium or electronic waste
BA19 batteri	Lead acid battery waste



## 8. Accessories

### 8.1 Battery

Mobilio can be powered by a backup battery which can be ordered separately. Always follow the instructions for proper use and installation, see 4.3.

Item number: 40-30762-2



### 8.2 Cushion for bed guards

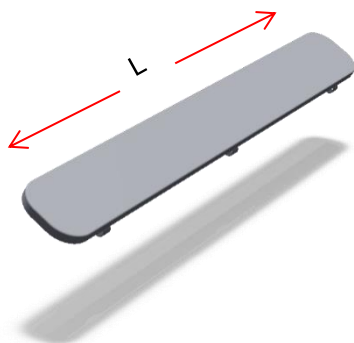

Item nr.	Size	Pcs.
40-25782-1	L= 148cm	1
40-25783-1	L= 178, 210cm	1

## 8.5 Central brake system

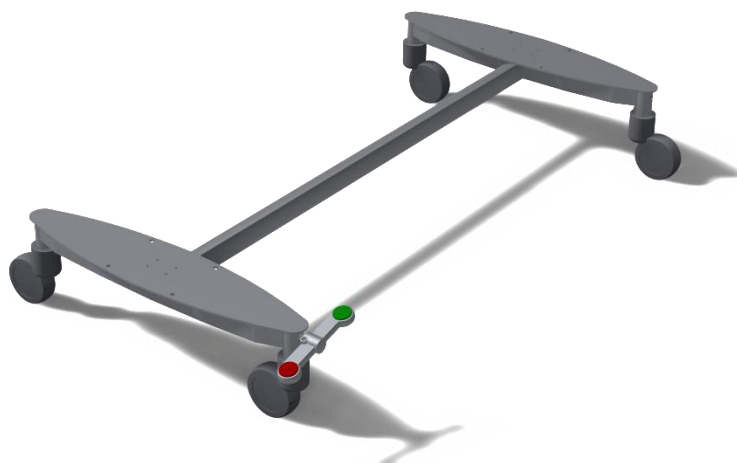

Item nr.	Size	Pcs
40-30753-2	L= 148cm	1
40-30760-2	L= 178cm	1
40-30763-2	L= 210cm	1

## 9. Electro magnetic compability

### 9.1 Suitable Environments

The device is suitable for use at home, at daycare centres, at day centres for persons with physical or mental disabilities or at hospitals except near active HF surgical equipment and the RF shielded room of an medical electrical system for magnetic resonance imaging, where the intensity of electromagnetic disturbances is high.

### 9.2 Basic safety and Essential performance

The device does not have any function related to basic safety or essential performance. In case of loss or degradation of performance, the user can get on and off the product.

### 9.3 Adjacent and stacked use

	<p><b>Warning !</b></p> <p>Use of this equipment adjacent to or stacked with other equipment should be voided because it could result in improper operation. If such use is necessary, this equipment and the other equipment should be observed to verify that they are operating normally</p>
---	---

## 9.4 Cables

Cable component	Length
Power cable	3,2m
Hand control spiral cable	Approx. 5m extended.

	<p><b>Warning!</b></p> <p>Use of accessories, transducers and cables other than those specified or provided by the manufacturer of this could result in increased electromagnetic emissions or decreased electromagnetic immunity of this equipment and result in improper operation.</p>
---	---

## 9.5 RF portable equipment

	<p><b>Warning !</b></p> <p>Portable RF communications equipment (including peripherals such as antenna cables and external antennas) should be used no closer than 30 cm (12 inches) to any part of the device, including cables specified by the manufacturer. Otherwise, degradation of the performance of this equipment could result.</p>
---	---

## 9.6 Compliance for emission and immunity standard

The product is tested and found compliant for EMC according to EN60601-1-2:2015 for Clause 7 and Clause 8. Documentation are tested and found compliant according to EN60601-1-2:2015 for Clause 5

### 9.6.1 Emission class and group

Phenomenon	Test method	Class	Group
Conducted RF emissions	EN 55011	Class B	Group 1
Radiated RF emissions	EN 55011	Class B	Group 1
Harmonic current emissions	EN 61000-3-2	Class A	-
Voltage changes, voltage fluctuations and flicker emissions	EN 61000-3-3	-	-

## 9.6.2 Immunity test levels

Phenomenon	Test method	Immunity test level
Electrostatic discharge immunity	EN 61000-4-2	+/- 8 kV contact +/- 2, 4, 8, 15 kV air
Electrostatic discharge immunity – I/O SIO/SOP ports	EN 61000-4-2	+/- 8 kV contact, +/- 2, 4, 8, 15 kV air Connectors shall be tested. Do not test pins, as they can not be contacted or touched, under conditions of intended use.
Radiated RF electromagnetic field immunity	EN 61000-4-3	10 V/m 80 MHz to 800 MHz 20 V/m 800 MHz to 2.5 GHz 10 V/m 2.5 GHz to 2.7 GHz 80 % AM 1 kHz
Immunity to proximity fields from RF wireless communication equipment	EN 61000-4-3	385 MHz, 27 V/m, 18 Hz PM (50 % duty cycle square wave) 450 MHz, 28 V/m, FM +/- 5 kHz dev., 1 kHz sine 710 MHz, 9 V/m, 217 Hz PM (50 % duty cycle square wave) 745 MHz, 9 V/m, 217 Hz PM (50 % duty cycle square wave) 780 MHz, 9 V/m, 217 Hz PM (50 % duty cycle square wave) 810 MHz, 28 V/m, 18 Hz PM (50 % duty cycle square wave) 870 MHz, 28 V/m, 18 Hz PM (50 % duty cycle square wave) 930 MHz, 28 V/m, 18 Hz PM (50 % duty cycle square wave) 1720 MHz, 28 V/m, 217 Hz PM (50 % duty cycle square wave) 1845 MHz, 28 V/m, 217 Hz PM (50 % duty cycle square wave) 1970 MHz, 28 V/m, 217 Hz PM (50 % duty cycle square wave) 2450 MHz, 28 V/m, 217 Hz PM (50 % duty cycle square wave) 5240 MHz, 9 V/m, 217 Hz PM (50 % duty cycle square wave) 5500 MHz, 9 V/m, 217 Hz PM (50 % duty cycle square wave) 5785 MHz, 9 V/m, 217 Hz PM (50 % duty cycle square wave)
Electrical fast transient/burst immunity – AC power ports	EN 61000-4-4	+/- 2 kV 100 kHz repetition frequency
Electrical fast transient/burst immunity – I/O SIO/SOP ports	EN 61000-4-4	+/- 1 kV 100 kHz repetition frequency
Surge immunity – AC power ports	EN 61000-4-5	Line-to-line: +/- 0.5, 1 kV line to line Line-to-ground: Not applicable, the device is a Class II device
Immunity to conducted disturbances induced by RF fields – AC power ports	EN 61000-4-6	3 V (6 V in ISM bands and amateur radio bands <sup>a</sup> ) 0.15-80 MHz 80 % AM 1 kHz
Immunity to conducted disturbances induced by RF fields – I/O SIO/SOP ports	EN 61000-4-6	3 V (6 V in ISM bands and amateur radio bands <sup>a</sup> ) 0.15-80 MHz 80 % AM 1 kHz
Power frequency magnetic field immunity	EN 61000-4-8	30 A/m 50 Hz and 60 Hz Test as tabletop equipment, for at least 1 minute in each direction
Voltage dips, short interruptions and voltage variations immunity	EN 61000-4-11	0 % U <sub>T</sub> ; 0.5 cycle at 0°, 45°, 90°, 135°, 180°, 225°, 270° and 315° 0 % U <sub>T</sub> ; 1 cycle at 0° 70 % U <sub>T</sub> ; 10 cycles at 0° 0 % U <sub>T</sub> ; 250 cycles at 0°
a) The ISM (industrial, scientific and medical) bands between 0.15 MHz and 80 MHz are 6.765 MHz to 6.795 MHz; 13.553 MHz to 13.567 MHz; 26.957 MHz to 27.283 MHz; and 40.66 MHz to 40.70 MHz. The amateur radio bands between 0.15 MHz and 80 MHz are 1.8 MHz to 2.0 MHz. 3.5 MHz to 4.0 MHz. 5.3 MHz to 5.4 MHz. 7 MHz to 7.3 MHz. 10.1 MHz to 10.15 MHz. 14 MHz to 14.2 MHz. 18.07 MHz to 18.17 MHz. 21.0 MHz to 21.4 MHz. 24.89 MHz to 24.99 MHz. 28.0 MHz to 29.7 MHz and 50.0 MHz to 54.0 MHz.		